



MODERN WIND-MILL DRIVE WITH FULL-POWER CONVERTER

November 18, 2011.



“WHEN THE WINDS OF CHANGE BLOW,
SOME PEOPLE BUILD WALLS AND
OTHERS BUILD WINDMILLS.”

Old Chinese proverb



THE SWITCH



WIND POWER

+5 to 10 GW yearly

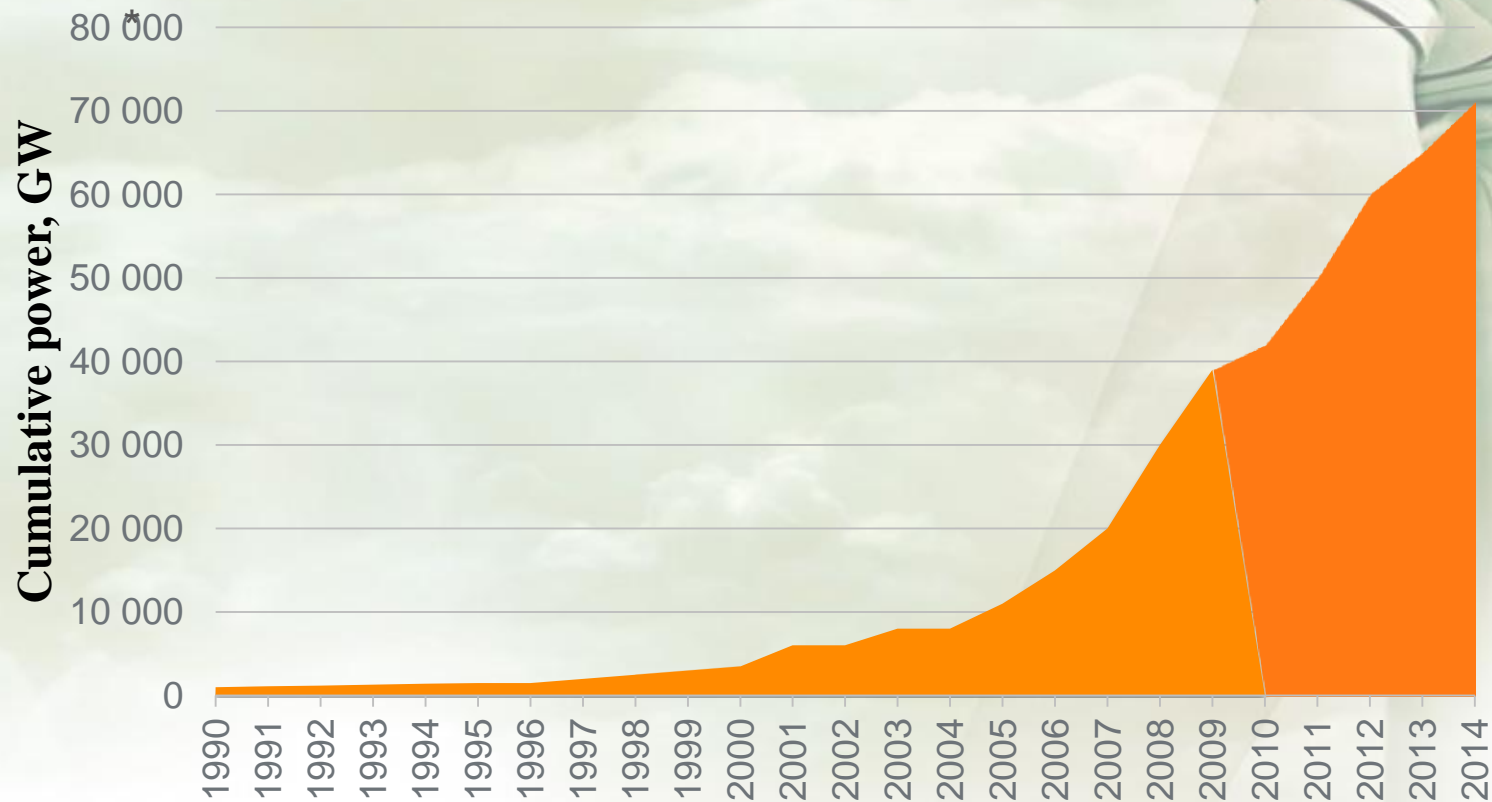

* New installations in MW

THE SWITCH

THE SWITCH DRIVE™

The soul of every reliable wind turbine



PERMANENT MAGNET
GENERATOR

FULL-POWER
CONVERTER



THE SWITCH

PORTFOLIO NOW



REFERENCES



ScanWind, Norway
3.7 MW DD package



Goldwind, China
1.5 MW and 2.5 MW FPC



Solar Systems, Australia
140 kW inverter



THE SWITCH

Bringing you power

GROWTH IN TURNOVER

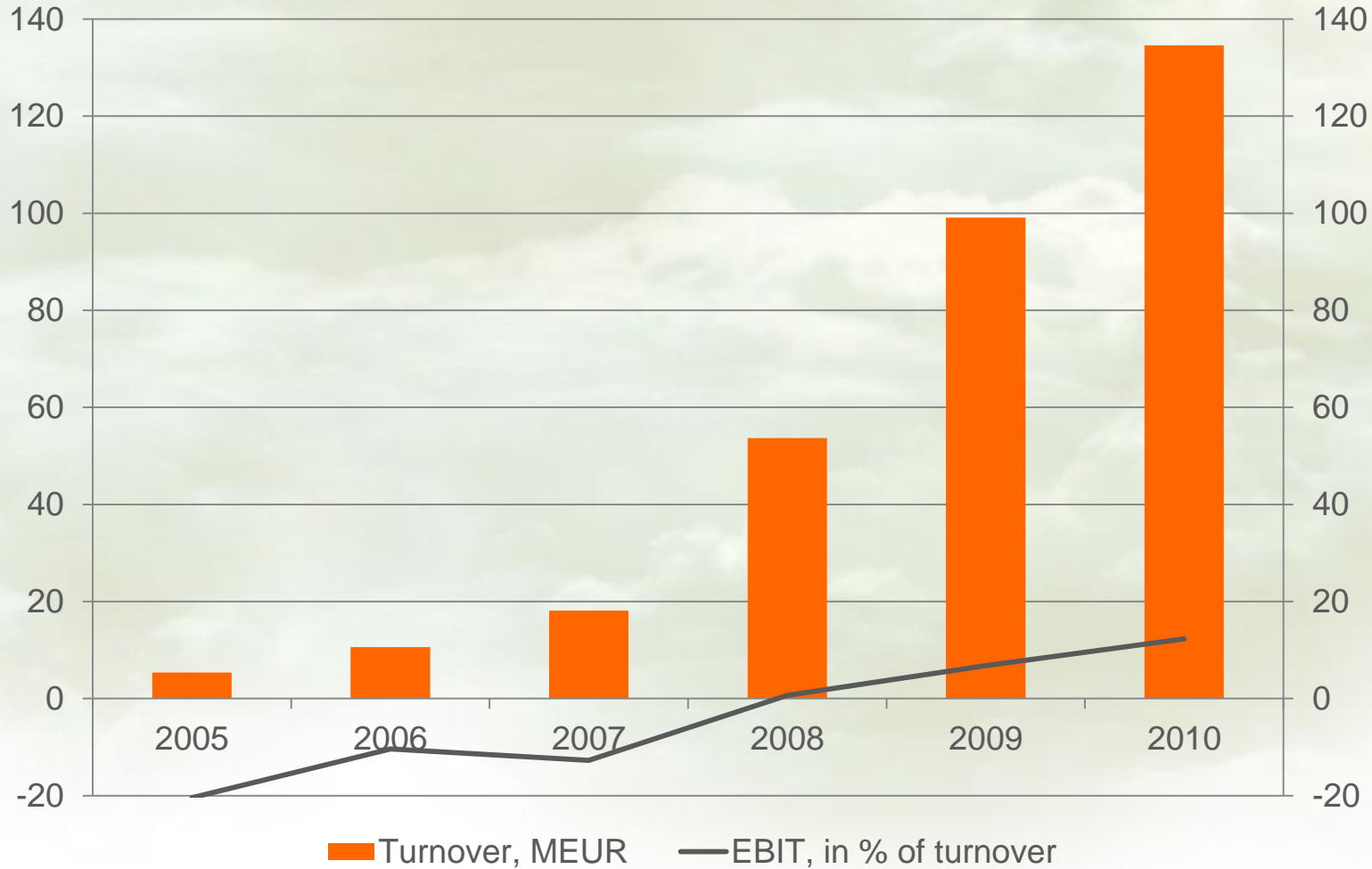

Due to a change of accounting policy from Finnish Accounting Standards (FAS) to International Financial Reporting Standards (IFRS), figures for 2010 and 2009 are not comparable with previous years.



TECHNOLOGY

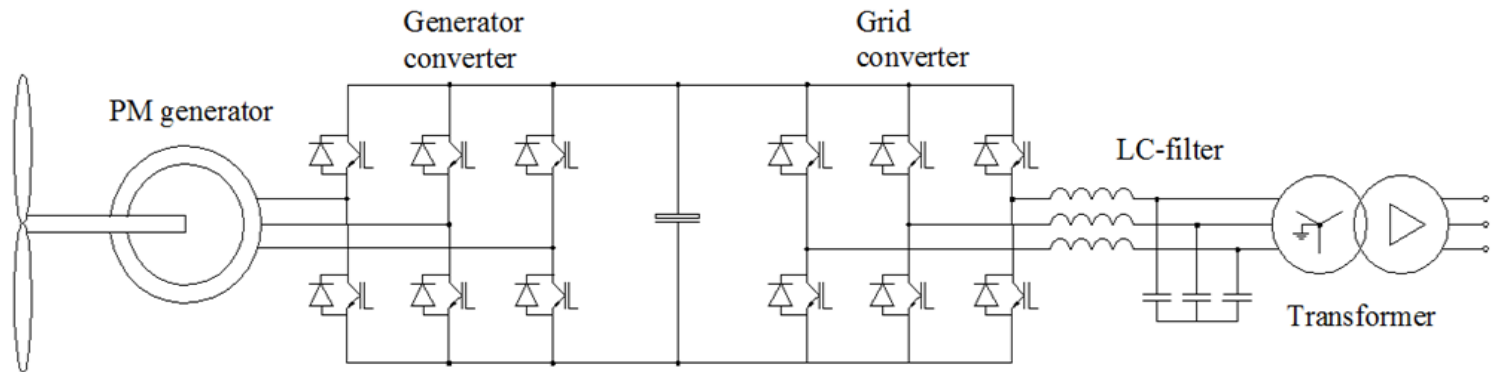

GENERATOR SIDE

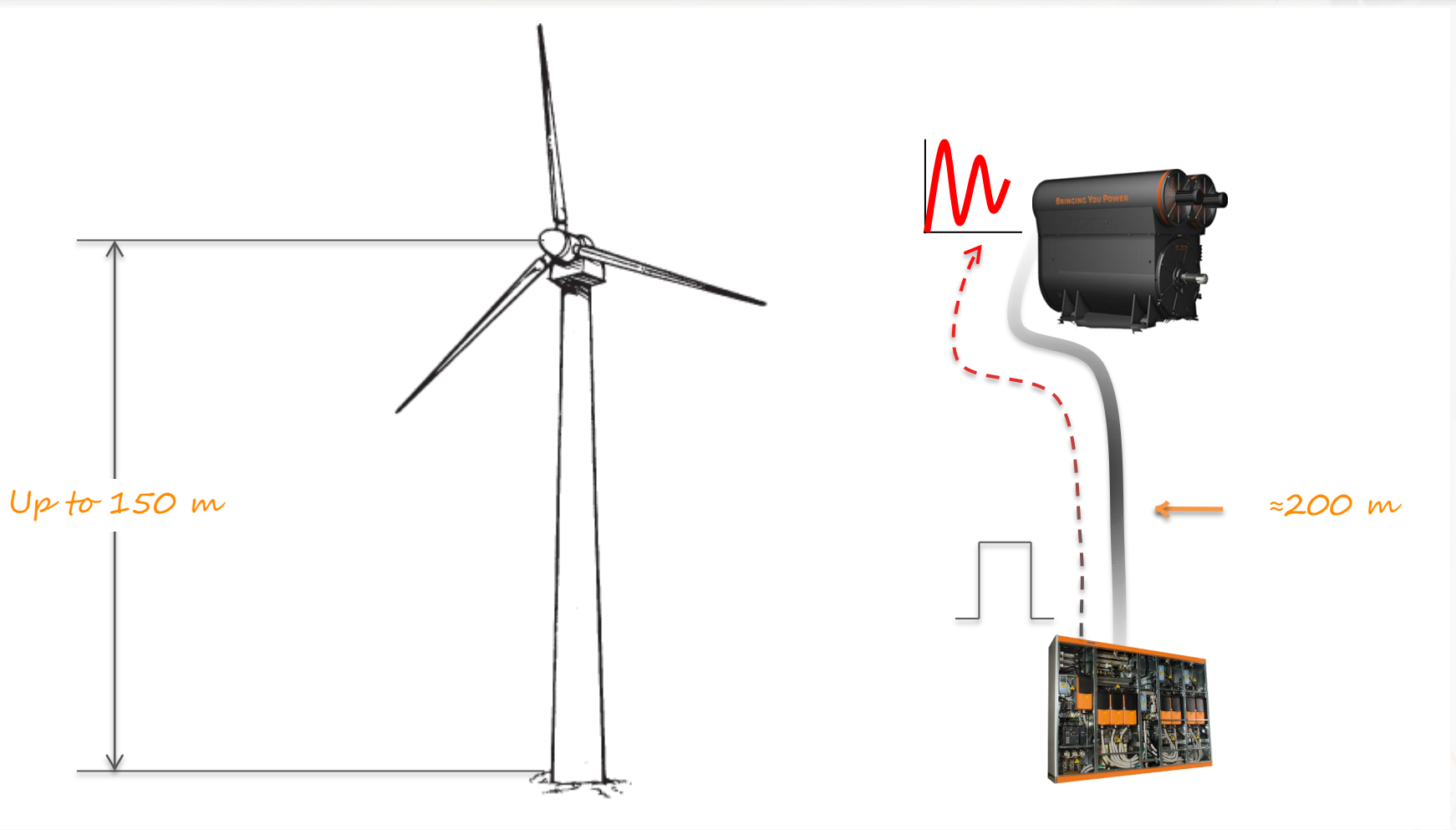

GRID SIDE

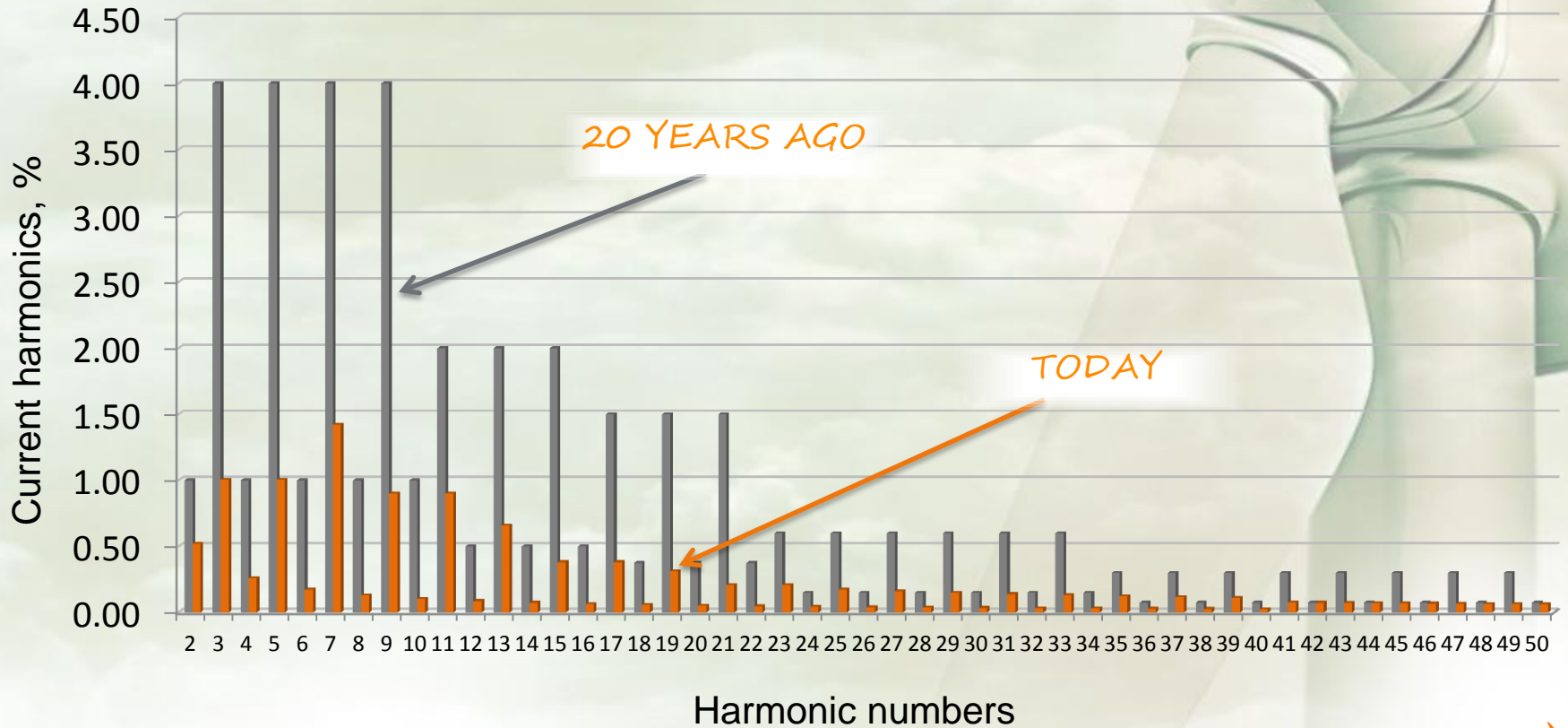

FILTRATION

FILTERS

GENERATOR
(du/dt)



GRID
(sinusoidal)

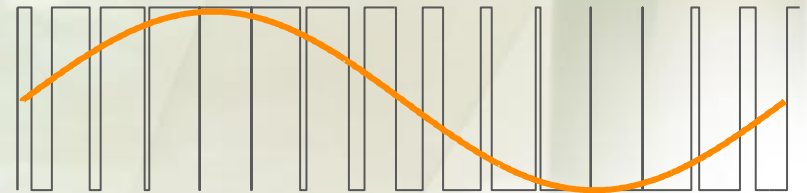

THE SWITCH CONVERTER

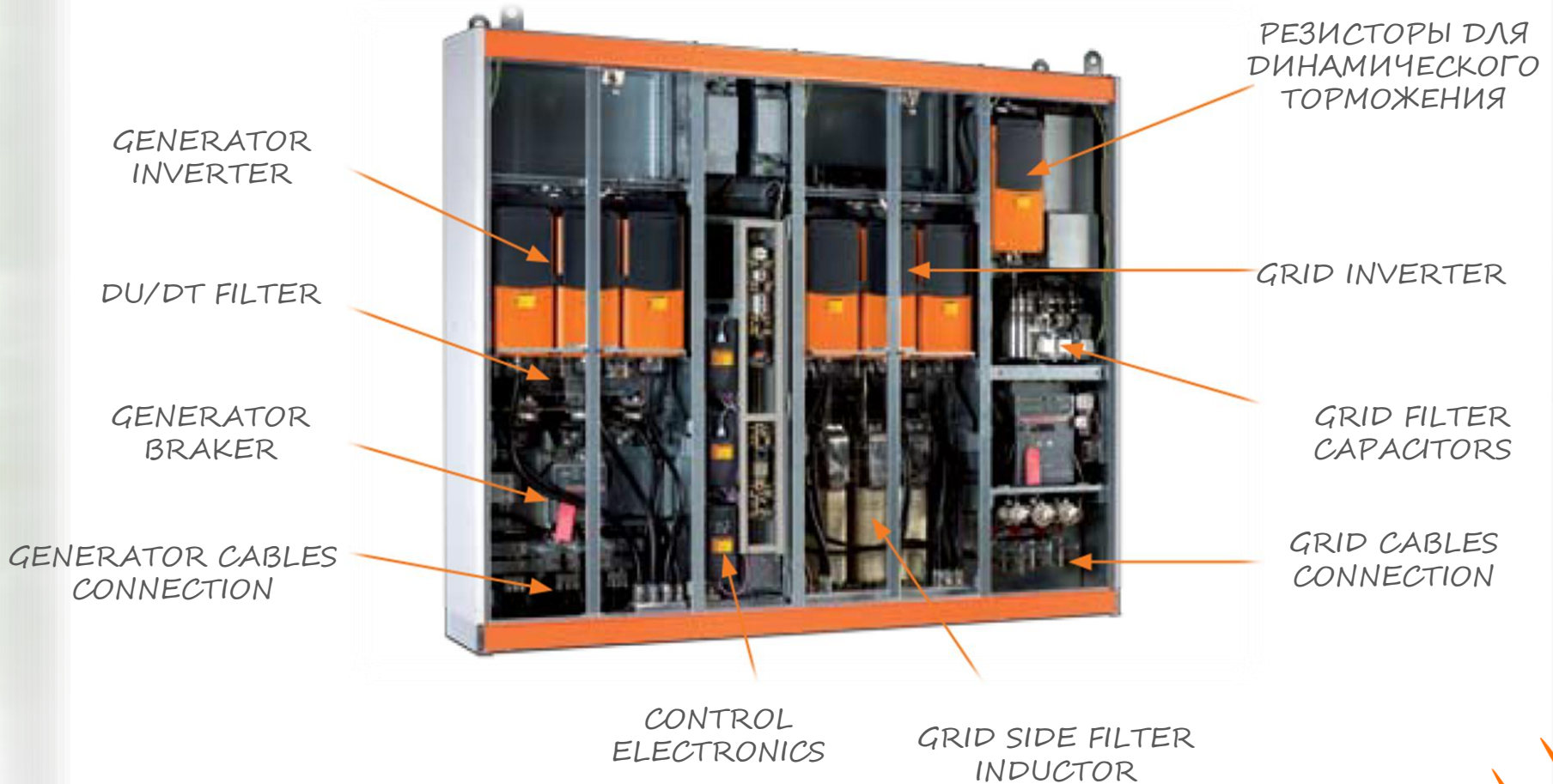

THE SWITCH

THANKS FOR ATTENTION!

Valentin Dzhankhotov, Dr.Sc, К.Т.Н.,
R&D Engineer, The Switch Drive Systems Oy
Valentin.Dzhankhotov@TheSwitch.com

Äyritie 8 C
FI-01510 Vantaa, Finland
Tel +358 20 783 8200
Fax +358 20 783 8570

